

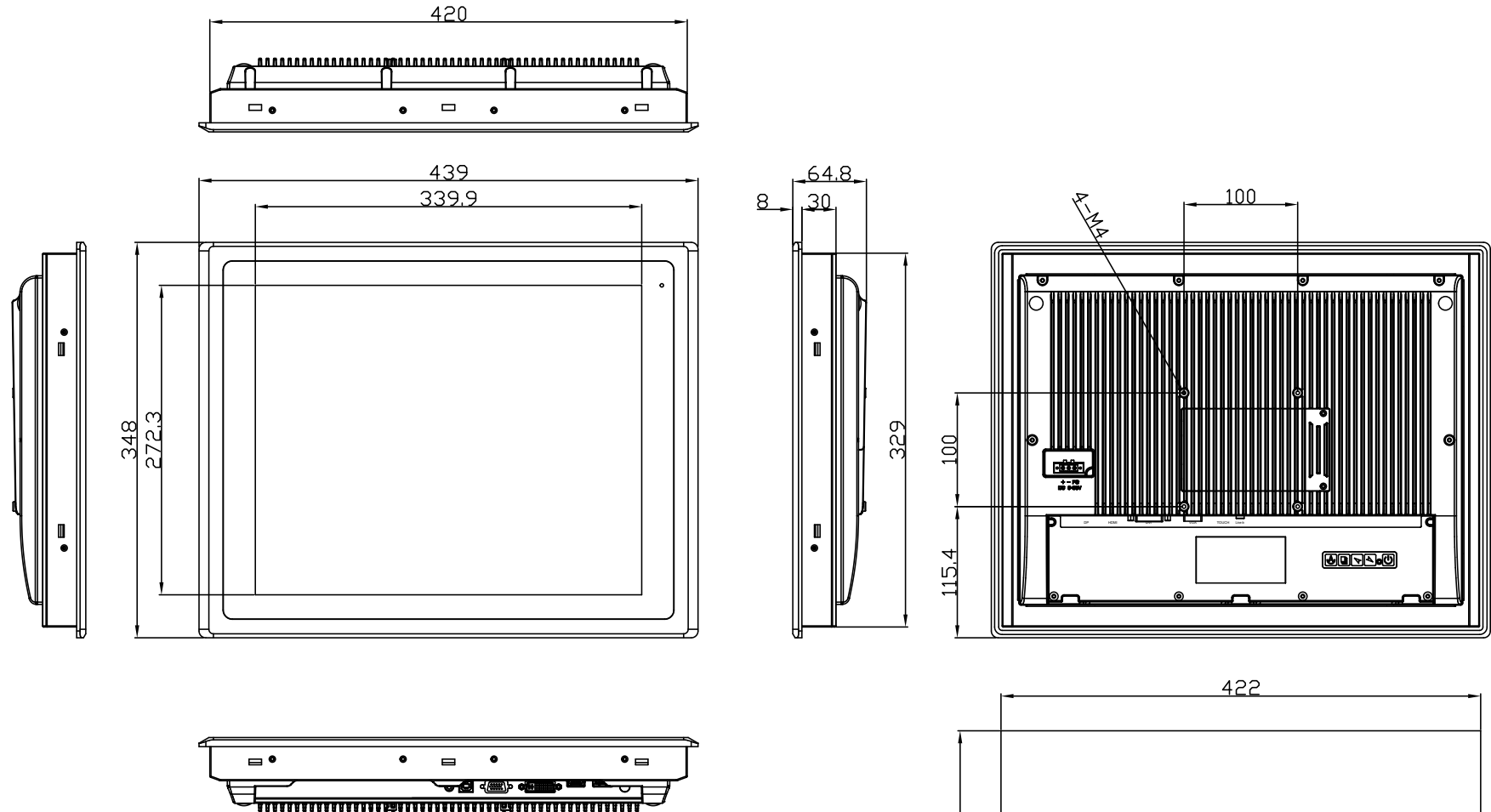

hematec SMART-VISU-100 17" (P) Dimensions

Unit: mm
Tolerance: +/- 0.5
Rev: 1.0
Date: Jan/22th 2025



UNIT: mm
Tolerance: ±0.5

